

Connection Technology Center, Inc.

590 Fishers Station Drive
Victor, New York 14564
Toll Free: (800) 999-5290
Phone: (585) 924-5900
Fax: (585) 924-4680

Measuring Fan and Motor Vibration



Fan & Motor Bearing Failures Can Be Prevented by Measuring Vibration

Common Machines

Quite often we view the fans and motors that we rely on as very common machines. We forget that they provide critical air flows for industrial processes, and cooling, heating, humidification and de-humidification for office buildings, convention centers, theaters, recreational facilities, and hotels.

Although they come in many shapes and sizes, fans and motors share a common mode of failure. Bearings are often overlooked and overworked suffering from lack of lubrication, too much heat, or poor applications. When this happens, the bearings wear and deteriorate, generating vibrations. Measuring the vibration and analyzing the faults will prevent catastrophic failures as shown in the photos.

A good routine vibration program using a portable data collector, or permanent on-line vibration monitoring, will become the foundation of any predictive maintenance initiative. Measuring, trending, alarming and analyzing fan and motor vibration will provide earlier warning of developing problems and allow replacement parts to be ordered. Bearings can be replaced during scheduled down times prior to non-repairable damage occurring.

Sensors

Accelerometers are typically placed at key locations on the motor and fan bearings. Since the bearings are the load carrying part of the mechanical drive train, accelerometers should be placed on the input and output

bearing housings to measure the vibration levels.



Permanent Accelerometers Placed on Motor and Fan Bearings

Vibration sensors should be placed in the radial (vertical & horizontal) and axial locations on the motor and fan bearings. This will provide the best detection of all vibration components including:

- bearing vibration
- unbalance
- misalignment
- electrical faults
- blade pass (aerodynamic disturbances)
- belt frequencies



Top Exit & Side Exit Multi-Purpose Accelerometers for Portable & Permanent Vibration Measurements

Portable Mounting

There are three common mounting methods for accelerometers used with portable vibration measurements.

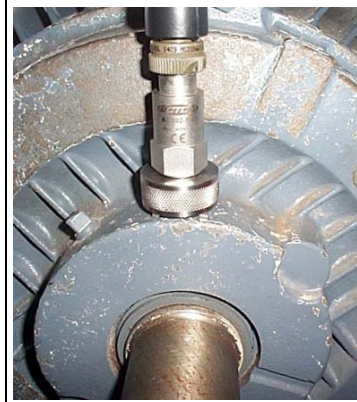

Curved Surface Magnet

- Easy & fits well on rounded surface
- Frequency response 2,000 Hz
- Repeatability based on user mounting

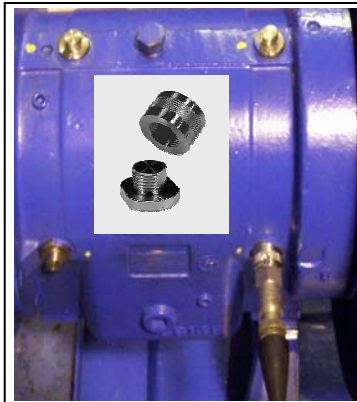

Quick Disconnects

- Easily mounted on permanent target
- Frequency response 6,500 Hz
- Excellent repeatability

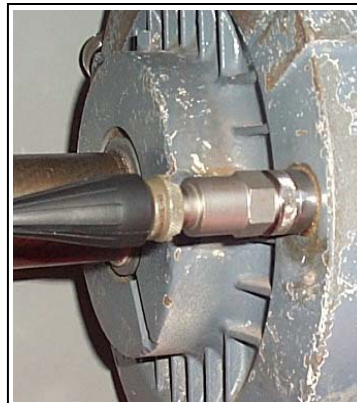

Flat Surface Magnet & Target

- Easily mounted on permanent target
- Frequency response 10,000 Hz
- Excellent repeatability

Permanent Mounting

Adhesive surface mounting and stud mounting are recommended for permanent installation of accelerometers. Both of these

techniques require surface preparation prior to mounting the sensor. Adhesive surface mounting requires a clean, dry, flat surface before cementing the mounting pad to the machine. Stud mounting requires a spot face with a drilled and tapped hole.

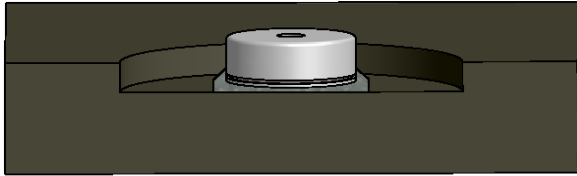

Mounting Pad Attached with Adhesive

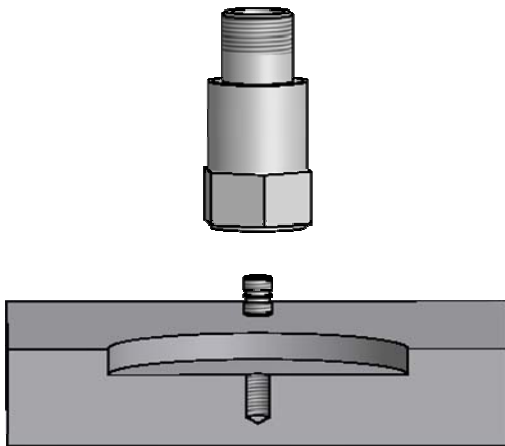

*Stud Mounted Accelerometer
Spot Face, Drill, Tap*

Since both methods require a flat prepared surface for mounting, spot facing is the easiest way to accomplish this. A spot facing tool can provide the flat surface and drill the hole in one operation.



Spot Facing Tool with Drill Bits

If the correct care is taken during permanent mounting, a frequency response of 15,000 Hz should be achievable with an adhesive mount, and the maximum frequency

response of the accelerometer should be achieved using a stud mount.



Tapping Spot Faced Mounting Location

Portable Cables & Connectors

Portable data collection requires a flexible cable and a connector with good strain relief. It needs to be easy to use, but very rugged for repetitive bending and stretching. The twisted shielded wiring pairs minimize noise.



Straight and Coiled Data Collector Cables

The sensor connector on the cable should be soldered and always have a good strain relief and fit comfortably in your hand.



Portable Connector with Strain Relief

Permanent Cables & Connectors

Permanent data collection utilizes a very rugged cable and connector that is intended to stay in place for the life of the machine. Cables should have heavy duty jackets to protect them from abrasion and the surrounding environment. Many applications utilize Teflon® jackets, and for severe environments, stainless steel armor jackets can be used.

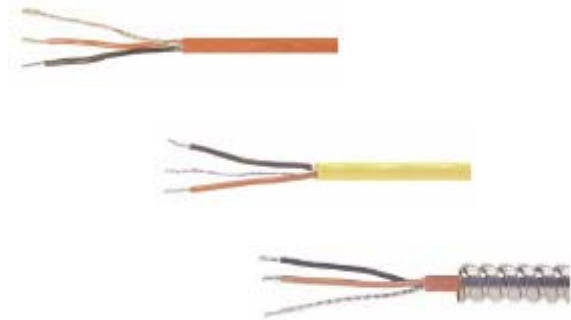

Permanent Twisted Shielded Pair Cables

Connectors for permanent data collection should also be chosen based on the application and environment. Temperature and Ingress Protection (IP) against liquids and dust should always be considered. Chemical contact should also be reviewed and planned for when choosing a connector or cable.

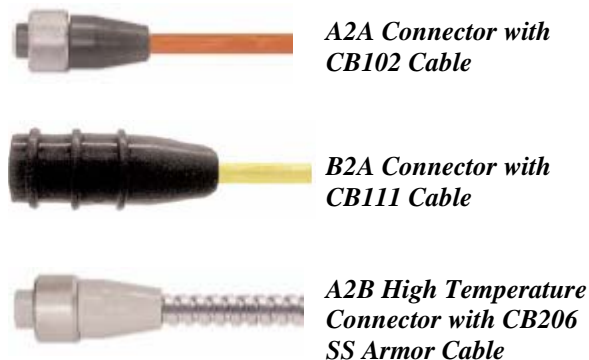

Choose the cable and connector that fits your application to avoid a weak link in the vibration measurement and data collection.

Cable Termination

The opposite end of the sensor cable needs to be organized and connected to portable or permanent vibration data collection. Wiring should be well laid out and labeled with identification tags.

- Simple portable data collection with an individual sensor and portable mount usually takes care of itself by directly mounting to the data collector.
- Using a portable data collector to measure permanently mounted sensors requires organization and termination of the sensor cables. A switch box is a convenient method.

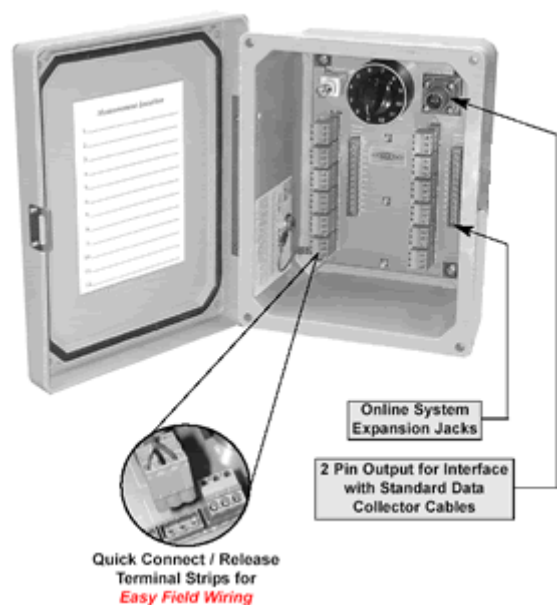

A Switch Box for Portable or Permanent Data Collection

- Permanent monitoring also requires organization and termination of the sensor cables. These can be organized as individual cables or combined in a cable reduction box with a large multi-conductor cable.

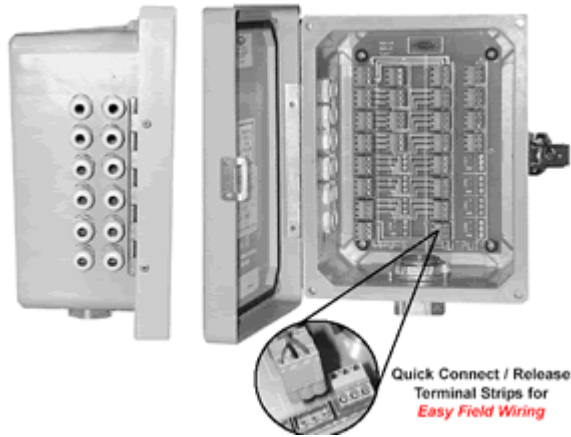

A Cable Reduction Box for Reducing Individual Sensor Cables into a Large Multi-Conductor Cable



Typical Multi-Conductor Cable

Plain Bearings

Some fans and motors are equipped with plain bearings. These bearings are often referred to as sleeve bearings or journal bearings. There are no rolling elements in a plain bearing, and typically the shaft is supported by a film or wedge of oil. In most cases, the primary measurement is the movement of the shaft inside the journal or sleeve. This type of measurement should be made with a displacement sensor (eddy current probe).

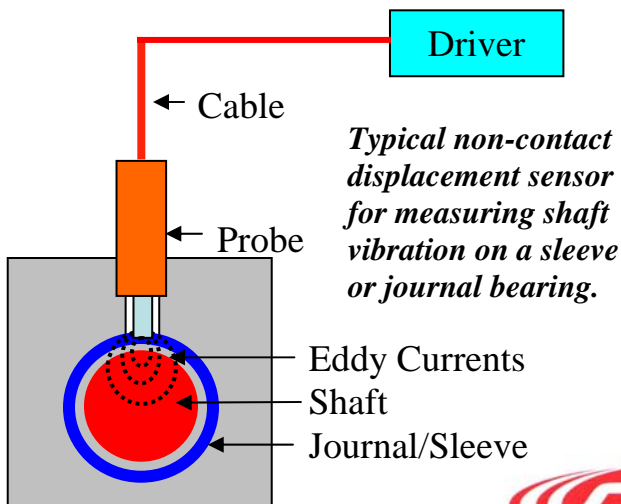

These non-contact sensors provide valuable information on the shaft vibration, and the gap between the shaft and journal or sleeve.



Displacement Probe & Driver

Summary

Vibration monitoring on fans and motors can be very beneficial. It doesn't matter if it is route based portable measurements or permanent monitoring. Both methods can achieve success providing better reliability and improved performance for any predictive maintenance program.

Mechanical and electrical defects can be identified through vibration analysis. Choosing the correct *sensor, mounting method, cable, and connector* will provide quality data. Organizing the sensor wiring in a *switch box or cable reduction box* reduces measurement errors.

Operator safety should never be compromised. Permanent sensors and cables keep fingers and hands out of where they shouldn't be!

Work safe, collect quality data, and enjoy the benefits of portable or permanent vibration measurements on your machines!